

Article number: 20135398

Description: E+G Ball knob DIN 319-KU-16-M4-E-MS

Measures

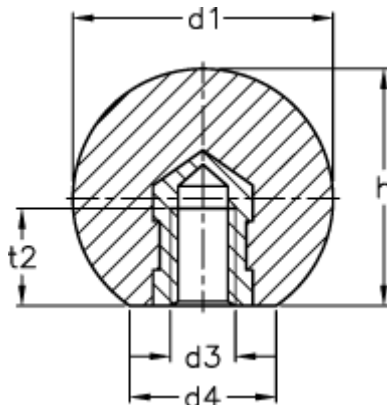

$d1$	= 16
$d3$	= M4
$d4$ approx.	= 8
h	= 15.0
$t2$ min.	= 6.0